

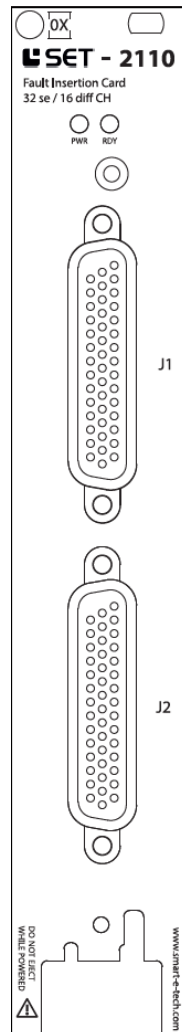

TECHNICAL DESCRIPTION

SET-2110

16 differential /32 single-ended channel fault insertion card



This document is a technical description of the SET-2110.

 **Note** Before you begin, complete the software and hardware installation procedures applicable to your application.

 **Note** The guidelines in this document are specific to the SET-2110. The other components in the system might not meet the same safety ratings. Refer to the documentation of each component in the system to determine the safety and EMC ratings for the entire system.

MORE INFORMATION ON OUR WEBSITE:

www.smart-e-tech.de/slsc

Safety Guidelines



Caution Do not operate the SET-2110 in a manner not specified in this document. Product misuse can result in a hazard. You can compromise the safety protection built into the product if the product is damaged in any way. If the product is damaged, return it for repair.

Electromagnetic Compatibility Guidelines

This product was tested and complies with the regulatory requirements and limits for electromagnetic compatibility (EMC). These requirements and limits provide reasonable protection against harmful interference when the product is operated in the intended operational electromagnetic environment.

This product is intended for use in industrial locations. However, harmful interference may occur in some installations, when the product is connected to a peripheral device or test object, or if the product is used in residential or commercial areas. To minimize interference with radio and television reception and prevent unacceptable performance degradation, install and use this product in strict accordance with the instructions in the product documentation.

Furthermore, any changes or modifications to the product not expressly approved by SET GmbH could void your authority to operate it under your local regulatory rules.



Caution To ensure the specified EMC performance, operate this product only with shielded cables and accessories.





Caution To ensure the specified EMC performance, the length of any cable attached to connectors J1 and J2 must be no longer than 3 m (10 ft.)

Description

The SET-2110 Fault Insertion Card is a large-scale, high density switching matrix. Each line of the 32 single-ended or 16 differential channels can be connected individually and flexibly to the high current fault injection bus. For this, one of both fault bus signal pairs can be selected dynamically for every channel. The SET-2110 Fault Insertion Card also provides the ability to generate short circuits between a channel's positive and negative signal. Unlike traditional routing matrix cards, the SET-2110 is designed specifically for the challenges of signal routing in HIL systems. To maximize customizability, the SET-2110 features two plug-in module slots that can provide additional features, such as instrument connect.

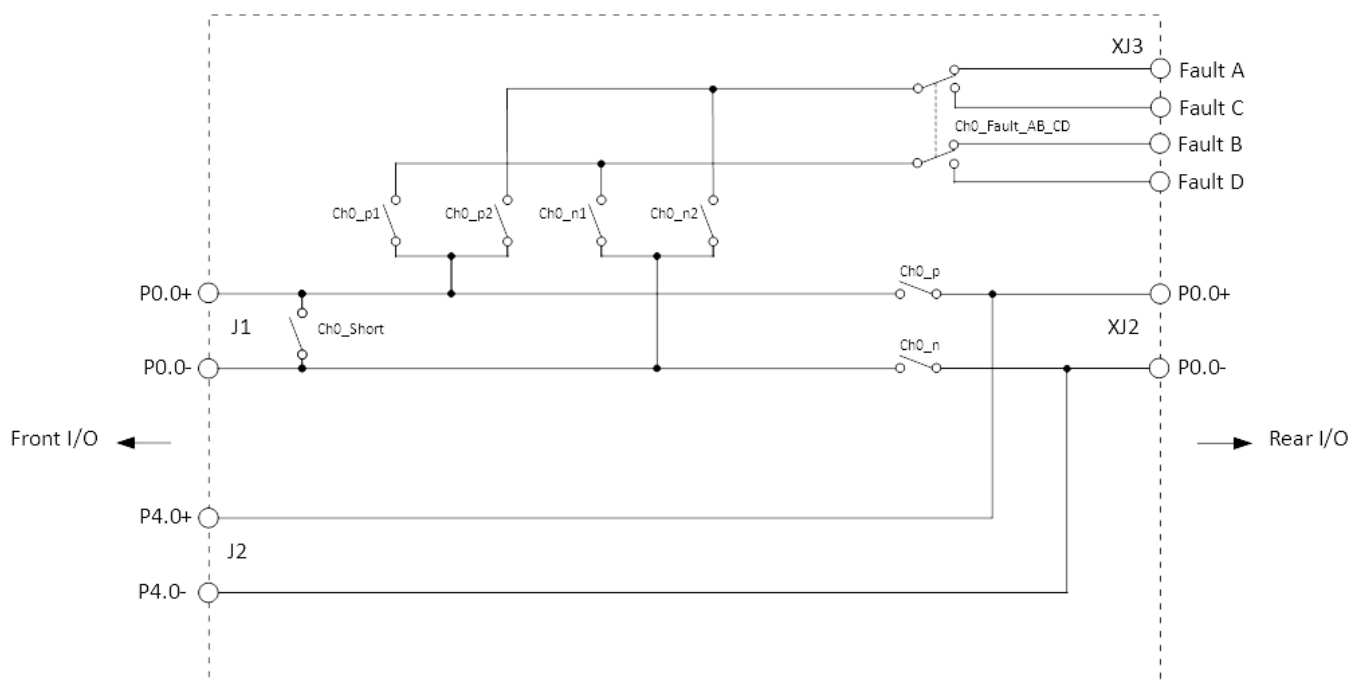
Circuitry



 **Note** Diagram only shows one channel.

J1, J2 Pinout (Front)

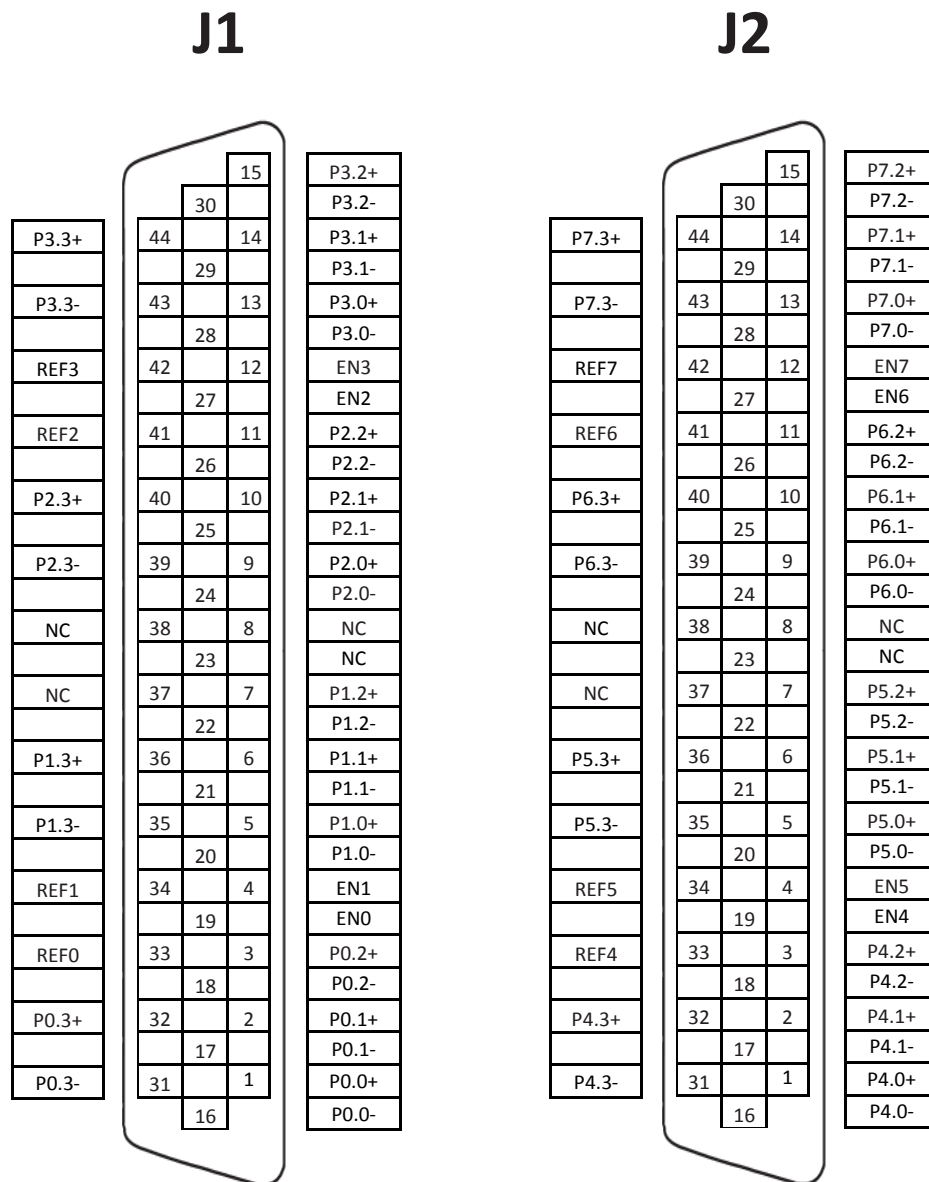

Signal	Description
Px.y	Line y in Port x
NC	No connection
EN	Enable
REF	Reference

J1, J2 Connector Pin Assignments

XJ2 Connector Pinout (Rear)

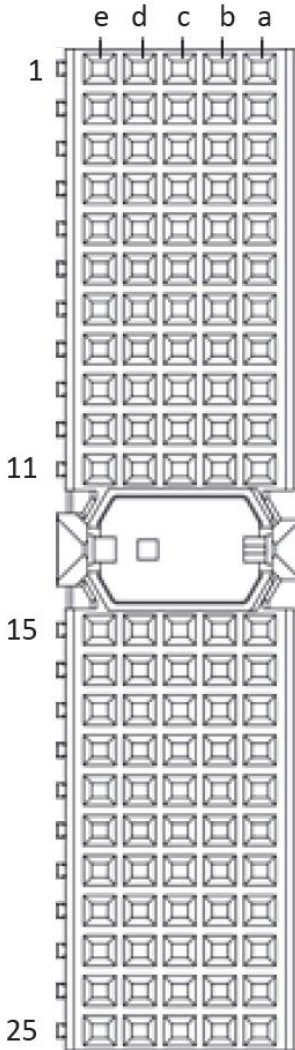

Row	e	d	c	b	a
1	P0.1- / P4.1-	P0.1+ / P4.1+	NC	P0.0- / P4.0-	P0.0+ / P4.0+
2	P0.3- / P4.3-	P0.3+ / P4.3+	NC	P0.2- / P4.2-	P0.2+ / P4.2+
3	GND	GND	GND	GND	GND
4	P1.1- / P5.1-	P1.1+ / P5.1+	NC	P1.0- / P5.0-	P1.0+ / P5.0+
5	P1.3- / P5.3-	P1.3+ / P5.3+	NC	P1.2- / P5.2-	P1.2+ / P5.2+
6	GND	GND	GND	GND	GND
7	P2.1- / P6.1-	P2.1+ / P6.1+	NC	P2.0- / P6.0-	P2.0+ / P6.0+
8	P2.3- / P6.3-	P2.3+ / P6.3+	NC	P2.2- / P6.2-	P2.2+ / P6.2+
9	GND	GND	GND	GND	GND
10	P3.1- / P7.1-	P3.1+ / P7.1+	NC	P3.0- / P7.0-	P3.0+ / P7.0+
11	P3.3- / P7.3-	P3.3+ / P7.3+	NC	P3.2- / P7.2-	P3.2+ / P7.2+
12	NC	NC	NC	NC	NC
13	NC	NC	NC	NC	NC
14	NC	NC	NC	NC	NC
15	NC	NC	NC	NC	NC
16	NC	NC	NC	NC	NC
17	GND	GND	GND	GND	GND
18	NC	NC	NC	NC	NC
19	NC	NC	NC	NC	NC
20	GND	GND	GND	GND	GND
21	NC	NC	NC	NC	NC
22	NC	NC	NC	NC	NC
23	GND	GND	GND	GND	GND
24	NC	NC	NC	NC	NC
25	NC	NC	NC	NC	NC

XJ2 Connector Pin Assignments

Signal	Description
Px.y	Line y in Port x
GND	Ground connection
NC	No connection

XJ2 Connector Signal Descriptions

XJ3 Connector Pinout (Rear)

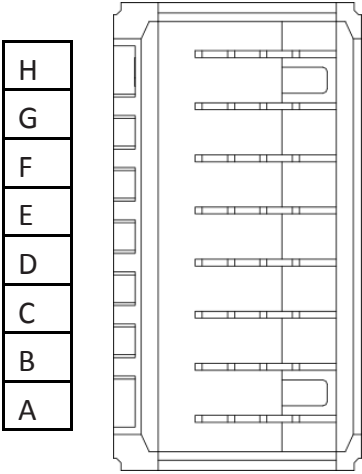

Pins	Signal	Slot1/Slot2
H	V1+	Instrument 0+
G	V1-	Instrument 0-
F	V2+	Instrument 1+
E	V2-	Instrument 1-
D	V3+	Fault A
C	V3-	Fault B
B	V4+	Fault C
A	V4-	Fault_D

XJ2 Connector Pin Assignments

LED Behavior

LED Name	LED Behavior	Definition of Behavior
PWR	Off	No power present on the board
	Solid green	Power good state
RDY	Off	Module card is unpowered or reset active
	Solid green	Card is recognized by chassis and ready to communicate
	Amber	Chassis is communicating

Error Handling

LED Name	LED Behavior	Actions
PWR	Off	<ul style="list-style-type: none">- Check power supply of chassis- Check external power supply if used
PWR	Blinking Red	<ul style="list-style-type: none">- Check plugin module on board- Check fuse on board

Hardware Specifications

Absolute Maximum Ratings			
Property	Condition	Value	Comment
Max. Input Voltage	Any Pin	60VDC	
Min. Input Voltage	Any Pin	-60VDC	
Max. Switching Power	DC, Resistive load	60W	
Max. Current Rating		1.5A	

Technical Data			
Property	Condition	Value	Comment
Update Time		10ms	SLSC Commit CMD duration
Max Initial Contact Resistance	J1 -> XJ2, J2-> XJ2, J1 -> J2	500 mΩ	
Expected Electrical Lifetime	1A, 30V _{DC} resistive	10 ⁵ operations	
	1.5A, 30V _{DC} resistive	10 ⁴ operations	
Bandwidth	-3dB, 50 Ω Termination	≤ 20 MHz	

Physicals Characteristics			
Property	Condition	Value	Comment
Module Dimensions	Excluding ejector	144.32mm x 30.48mm x 302mm (H x W x D)	Standard SLSC card size
Front Panel Connector		2x female DB -44 high-density D-Sub with 4-40 UNC screw lock	For mating connectors and cables, see below
RTI Connector		2mm hard metric per IEC 61076-101	Any RTI marked

Hardware Specifications

Environmental			
Property	Condition	Value	Comment
Operating Humidity	Relative, non-condensing	10%-90%	
Storage Humidity	Relative, non-condensing	5%-95%	
Operating Temperature	Forced-air cooling from chassis	0°C-40°C	
Storage Temperature		-40°C-85°C	
Maximum Altitude		2000m	