

TECHNICAL DESCRIPTION

SET-1623

32 TX/RX Channel Software Selectable Direction

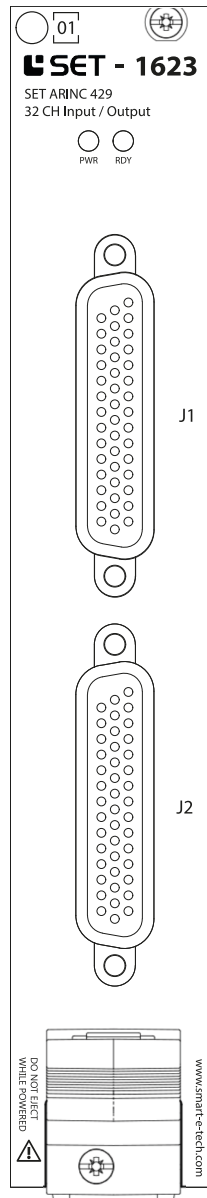

This document is a technical description of the SET-1623.



Note Before you begin, complete the software and hardware installation procedures applicable to your application.



Note The guidelines in this document are specific to the SET-1623. The other components in the system might not meet the same safety ratings. Refer to the documentation of each component in the system to determine the safety and EMC ratings for the entire system.

MORE INFORMATION ON OUR WEBSITE:

www.smart-e-tech.com/slsc

Safety Guidelines



Caution Do not operate the SET-1623 in a manner not specified in this document. Product misuse can result in a hazard. You can compromise the safety protection built into the product if the product is damaged in any way. If the product is damaged, return it for repair.

Electromagnetic Compatibility Guidelines

This product was tested and complies with the regulatory requirements and limits for electromagnetic compatibility (EMC). These requirements and limits provide reasonable protection against harmful interference when the product is operated in the intended operational electromagnetic environment.

This product is intended for use in industrial locations. However, harmful interference may occur in some installations, when the product is connected to a peripheral device or test object, or if the product is used in residential or commercial areas. To minimize interference with radio and television reception and prevent unacceptable performance degradation, install and use this product in strict accordance with the instructions in the product documentation.

Furthermore, any changes or modifications to the product not expressly approved by SET GmbH could void your authority to operate it under your local regulatory rules.



Caution To ensure the specified EMC performance, operate this product only with shielded cables and accessories.



Caution To ensure the specified EMC performance, the length of any cable attached to connectors J1 and J2 must be no longer than 3 m (10 ft.)

Description

The SET 1623 ARINC Card offers a wide range for numerous areas of applications. The SET 1623 ARINC Card has 32 Tx/Rx Channels. The 32 Tx/Rx channels are structured in 4 banks (P0.x to P3.x) 8 channels each. Each banks is controlled by a dedicated SPI (SPI0 to SPI3) located on RTI.

The direction is selectable by software for each channel. Individual transfer rate switchover for each Tx channel and automatic transfer rate recognition on Rx channels. Message reception and itemization by label in hardware and additional direct access to the transmitter and receiver unit.

Circuitry

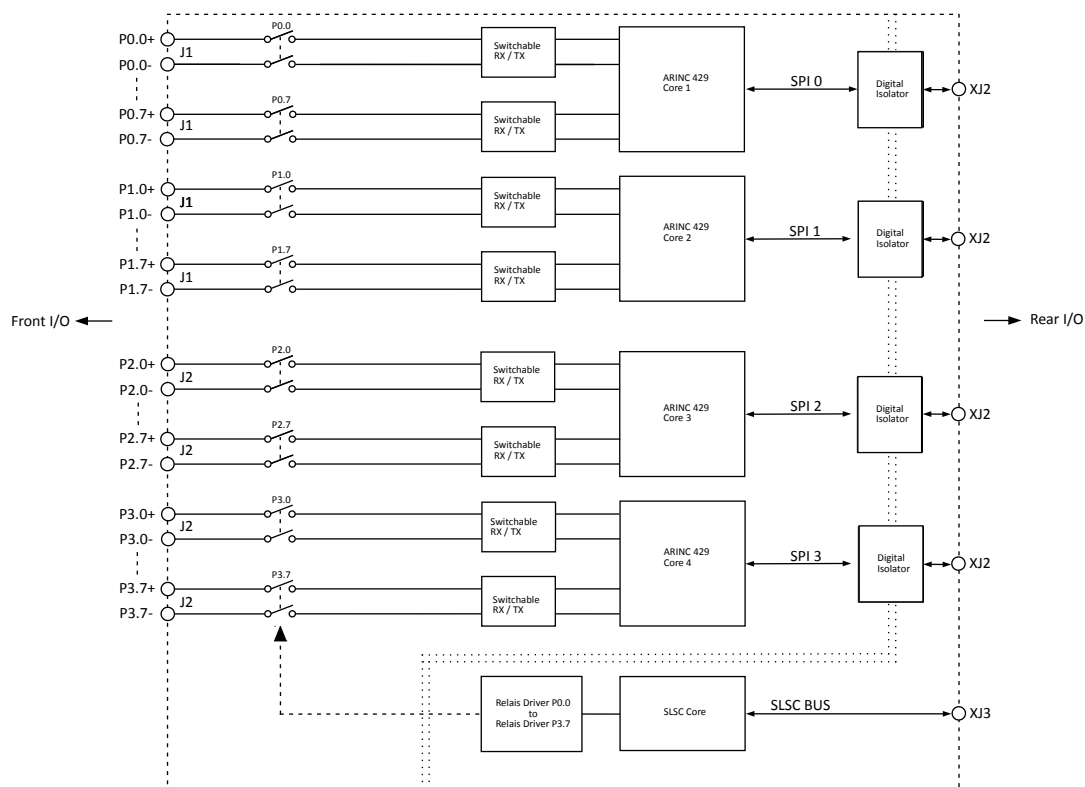

 **Note** Diagram only shows one channel per front connector J1.

All voltages are relative to DGND unless otherwise noted.

ARINC 429 Core Block Diagram

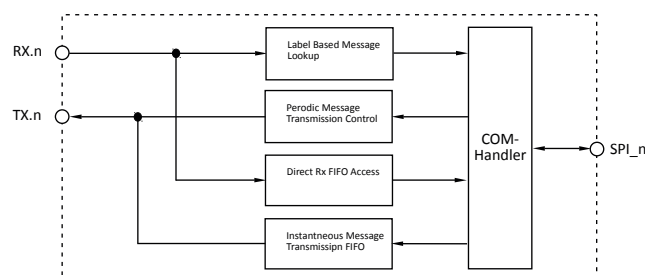

J1, J2 Pinout (Front)

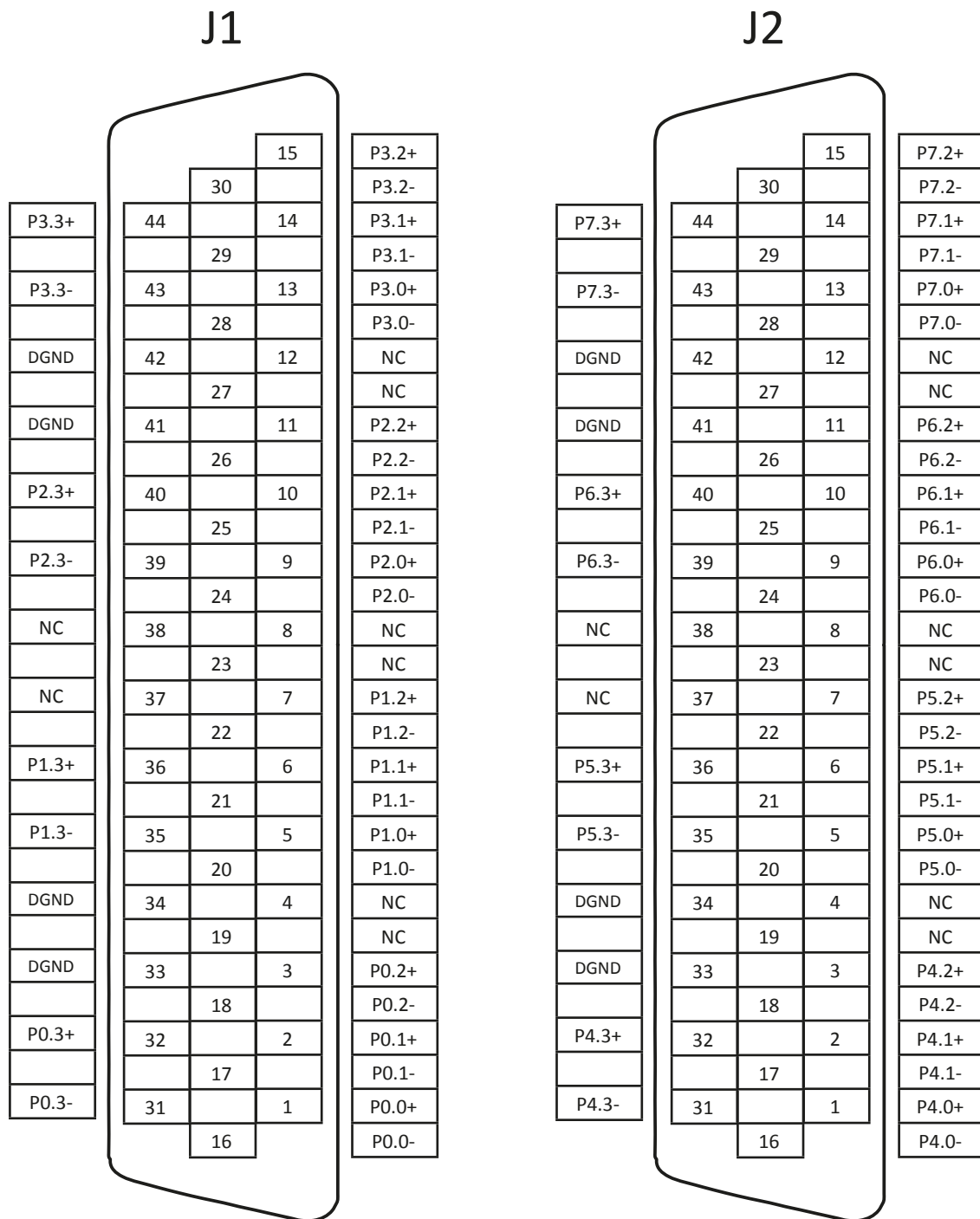

Signal	Description
Px.y +	Channel y in Bank x, ARINC A
Px.y -	Channel y in Bank x, ARINC B
DGND	Ground connection
NC	Not connected

JR1, JR2 Connector Pin Assignments

XJ2 Connector Pinout (Rear)

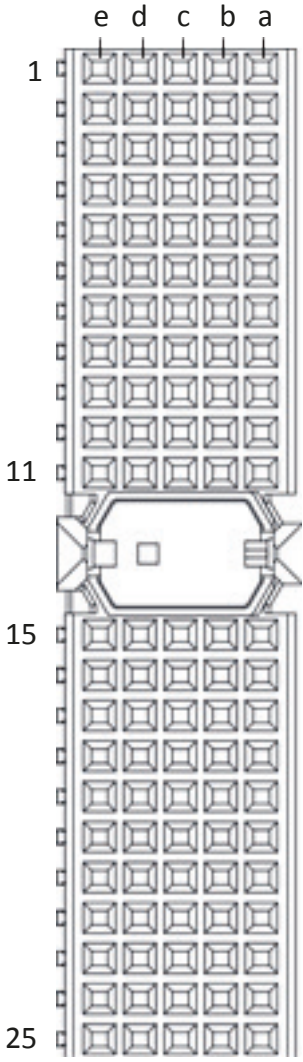

Row	a	b	c	d	e
1	SPI_0_/CS	SPI_0_CLK	NC	SPI_0_MOSI	SPI_0_/ID
2	SPI_0_MISO	SPI_0_FUNC	NC	NC	NC
3	DGND	DGND	DGND	DGND	DGND
4	SPI_1_/CS	SPI_1_CLK	NC	SPI_1_MOSI	SPI_1_/ID
5	SPI_1_MISO	SPI_1_FUNC	NC	NC	NC
6	DGND	DGND	DGND	DGND	DGND
7	SPI_2_/CS	SPI_2_CLK	NC	SPI_2_MOSI	SPI_2_/ID
8	SPI_2_MISO	SPI_2_FUNC	NC	NC	NC
9	DGND	DGND	DGND	DGND	DGND
10	SPI_3_/CS	SPI_3_CLK	NC	SPI_3_MOSI	SPI_3_/ID
11	SPI_3_MISO	SPI_3_FUNC	NC	NC	NC
12	NC	NC	NC	NC	NC
13	NC	NC	NC	NC	NC
14	NC	NC	NC	NC	NC
15	NC	NC	NC	NC	NC
16	NC	NC	NC	NC	NC
17	DGND	DGND	DGND	DGND	DGND
18	NC	NC	NC	NC	NC
19	NC	NC	NC	NC	NC
20	DGND	DGND	DGND	DGND	DGND
21	NC	NC	NC	NC	NC
22	NC	NC	NC	NC	NC
23	DGND	DGND	DGND	DGND	DGND
24	NC	NC	NC	NC	NC
25	NC	NC	NC	NC	NC

XJ2 Connector Pin Assignments

Signal	Description
DGND	Ground connection
NC	Not connected
SPI_X_/CS	Chipselect
SPI_X_MISO	MasterIn/SlaveOutput
SPI_X_MOSI	MasterOut/SlaveInput
SPI_X_CLK	Clock
SPI_X_/ID	Tide to High if unused
SPI_X_Func	Tide to High or Left Floating if unused

XJ2 Connector Signal Descriptions

XJ3 Connector Pinout (Rear)

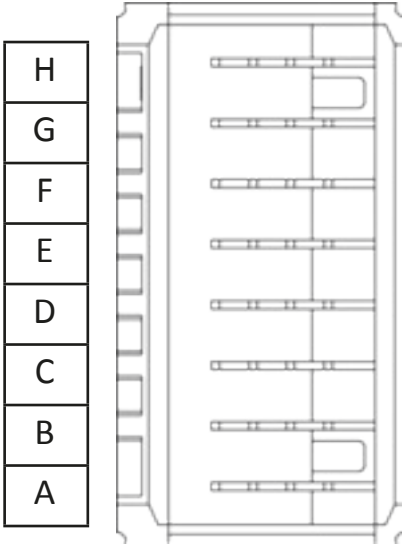

Pins	Signal	Slot1/Slot2
H	V1+	Instrument_0+
G	V1-	Instrument_0-
F	V2+	Instrument_1+
E	V2-	Instrument_1-
D	V3+	Fault_A
C	V3-	Fault_B
B	V4+	Fault_C
A	V4-	Fault_D

XJ3 Connector Pin Assignments

 **Note** Not recommended RTI 12301 from National Instruments.

LED Behavior

LED Name	LED Behavior	Defintion of Behavior
PWR	Off	No power on the board
	Solid green	Power good state
RDY	Off	Module card is unpowered or reset active
	Solid green	Card is recognized by the chassis and ready to communicate
	Amber	Chassis is communicating

Error Handling

LED Name	LED Behavior	Actions
PWR	Off	- Check the power supply of the chassis



Note Diagram only shows one channel per front connector J1.

Hardware Specifications

Absolut Maximum Ratings			
Property	Condition	Value	Comment
Channel Short Circuit	cont.	80 mA	when in Tx mode
Any Pin to ARINC Reference		+/-7 V	
Any Pin to Chassis GND		max 60 V	

Technical Data			
Property	Condition	Value	Comment
Number Channels		32	
Direction		Rx/Tx	Software-selectable for each channel
Bit Rate Tx		100 kb/s / 12,5 kb/s	Software-selectable for each channel
Bit Rate Rx		100 kb/s +/- 1% 12.0 kb/s to 14.5 kb/s +/-1%	auto-detected for each channel
Scheduling Slots	per channel	256 slots	label used as index per default
Indexing Slots	per channel	256 slots	label used as index per default

Hardware Specifications

Physical Characteristics			
Property	Condition	Value	Comment
Module Dimensions	Excluding ejector	144.32mm x 30.48mm x 302mm (H x W x D)	Standard SLSC card size
Front Panel Connector		2x female DB -44 high-density D-Sub with 4-40 UNC screw lock	
RTI Connector		2mm hard metric per IEC 61076-101	Any RTI marked

Environmental			
Property	Condition	Value	Comment
Operating Humidity	Relative, non-condensing	10%-90%	
Storage Humidity	Relative, non-condensing	5%-95%	
Operating Temperature	Forced-air cooling from chassis	0°C-40°C	
Storage Temperature		-40°C-85°C	
Maximum Altitude		2000m	