

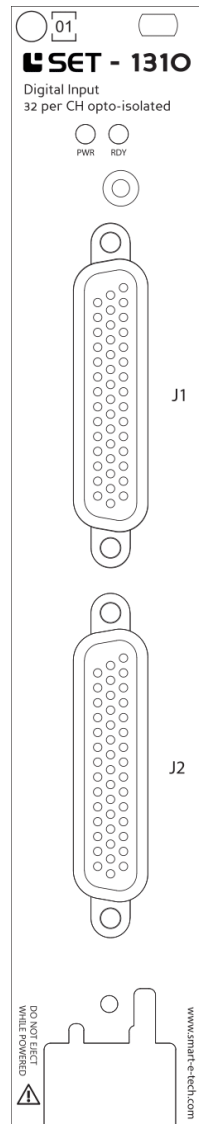

## TECHNICAL DESCRIPTION

# SET-1310

32 Channel Isolated Digital Input, 3.3 V to 60 V.



This document 9040TDD1010 is a technical description of the SET-1310.

 **Note** Before you begin, complete the software and hardware installation procedures applicable to your application.

 **Note** The guidelines in this document are specific to the SET-1310. The other components in the system might not meet the same safety ratings. Refer to the documentation of each component in the system to determine the safety and EMC ratings for the entire system.

### MORE INFORMATION ON OUR WEBSITE:

[www.smart-e-tech.de/slsc](http://www.smart-e-tech.de/slsc)

# Safety Guidelines

---



**Caution** Do not operate the SET-1310 in a manner not specified in this document. Product misuse can result in a hazard. You can compromise the safety protection built into the product if the product is damaged in any way. If the product is damaged, return it for repair.

## Electromagnetic Compatibility Guidelines

---

This product was tested and complies with the regulatory requirements and limits for electromagnetic compatibility (EMC). These requirements and limits provide reasonable protection against harmful interference when the product is operated in the intended operational electromagnetic environment.

This product is intended for use in industrial locations. However, harmful interference may occur in some installations, when the product is connected to a peripheral device or test object, or if the product is used in residential or commercial areas. To minimize interference with radio and television reception and prevent unacceptable performance degradation, install, and use this product in strict accordance with the instructions in the product documentation.

Furthermore, any changes or modifications to the product not expressly approved by SET GmbH could void your authority to operate it under your local regulatory rules.



**Caution** To ensure the specified EMC performance, operate this product only with shielded cables and accessories.



**Caution** To ensure the specified EMC performance, the length of any cable attached to connectors J1 and J2 must be no longer than 3 m (10 ft.)

# Description

The SET-1310 device is an isolated digital input interface for NI-SLSC. This card provides 32 optically isolated digital inputs. SET-1310 combines high-density IO with high isolation voltages and a wide input voltage range. It allows you to break ground loops and protect your system from high voltage spikes, but also to connect high voltage signals to standard logic level acquisition devices. The channel-to-channel isolation allows to connect signals from different DUTs to a single acquisition system.

The digital inputs feature a wide supply voltage range and can be used with a variety of signal levels, including 12 V and 28 V discrete signals.

The high-speed, high sensitivity optoisolators allow reliable input detection with an input current as low as 6 mA. To protect the optoisolators, each input contains a current limiting circuit which limits the input current to 6 mA over the entire input voltage range.

With a maximum voltage channel to channel and channels to chassis of 60 Vdc, SET-1310 allows you to connect multiple DUTs operating at most usual logic levels to a single data acquisition system.

# Circuitry

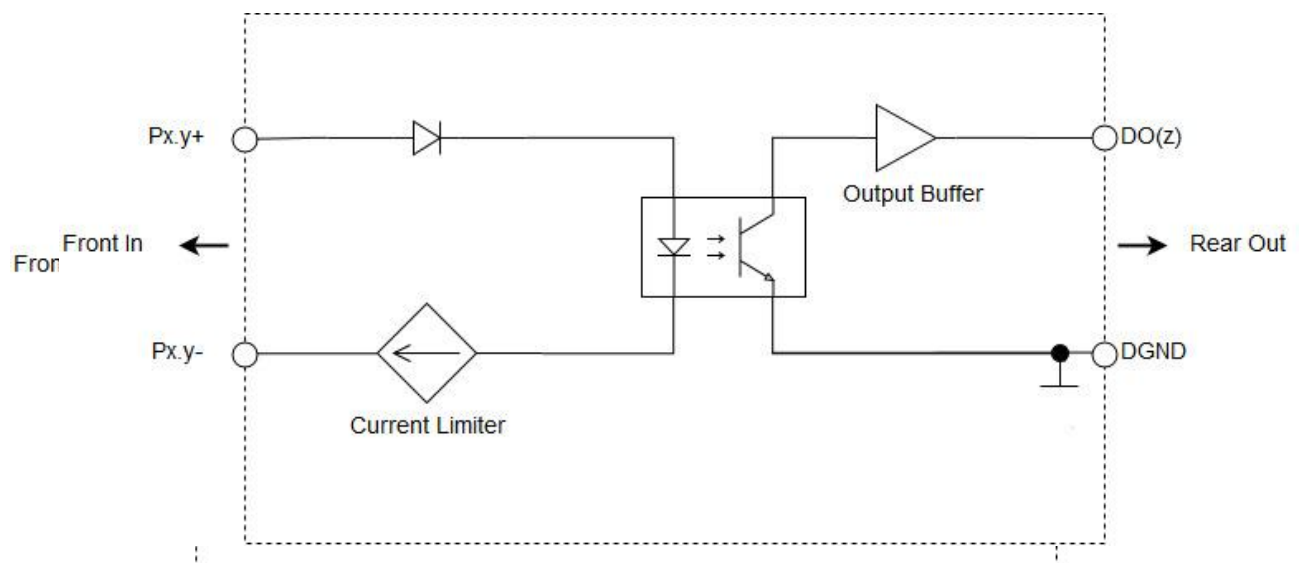

 **Note** Diagram only shows one channel.

All voltages are relative to DGND unless otherwise noted.

 **Note** You can configure the power-on configuration in the software. The factory default power-on configuration sets the front I/O Channels to sinking input and rear I/O channels to output.

# J1, J2 Pinout (Front)

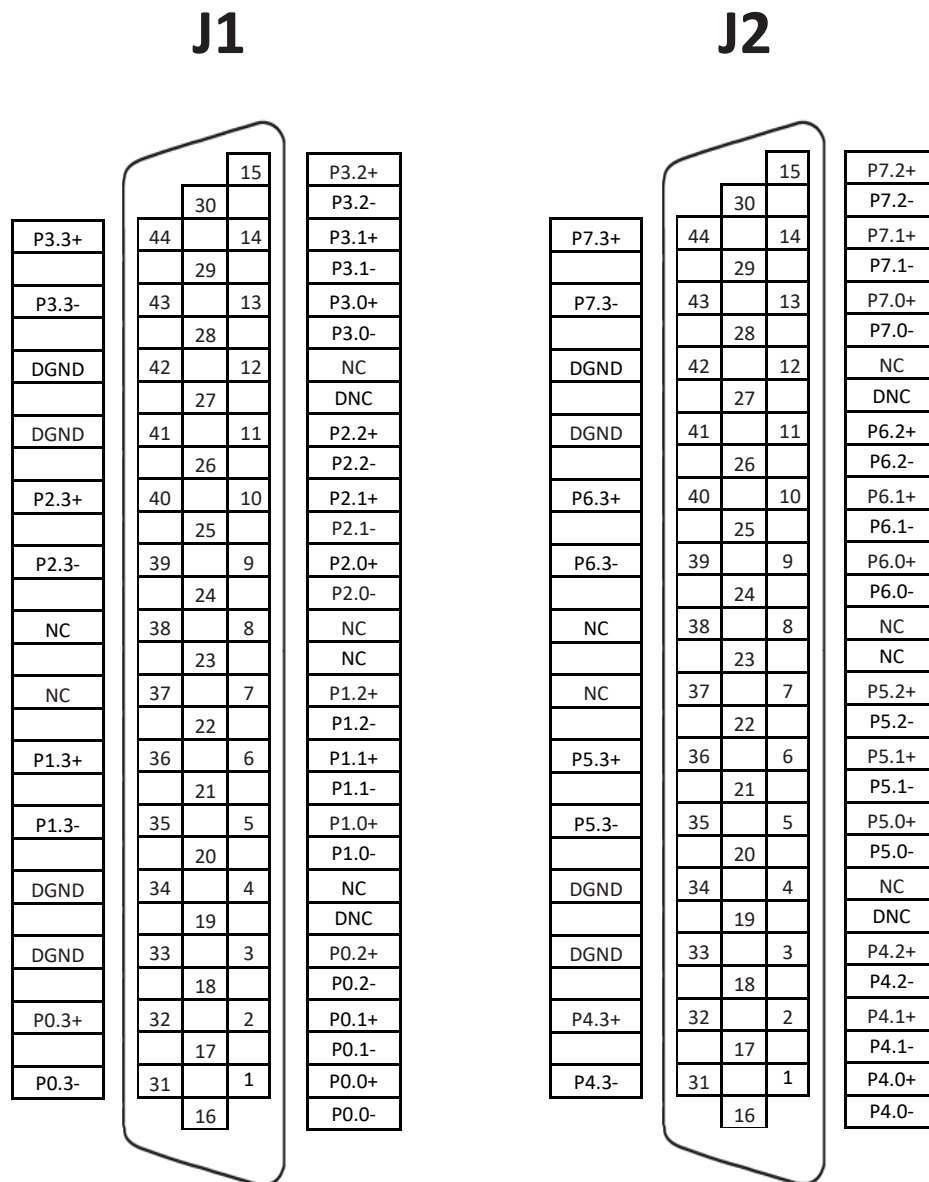

Signal	Description
Px.y	Line y in Port x
NC	No connection
DGND	Ground connection
DNC	Do not connect

J1, J2 Connector Pin Assignments

<b>J1</b>	<b>XJ2</b>	<b>J2</b>	<b>XJ2</b>
P0.0 +	DO0	P4.0 +	DO16
P0.0 -		P4.0 -	
P0.1+	DO1	P4.1+	DO17
P0.1 -		P4.1 -	
P0.2 +	DO2	P4.2 +	DO18
P0.2 -		P4.2 -	
P0.3 +	DO3	P4.3 +	DO19
P0.3 -		P4.3 -	
P1.0 +	DO4	P5.0 +	DO20
P1.0 -		P5.0 -	
P1.1 +	DO5	P5.1 +	DO21
P1.1 -		P5.1 -	
P1.2 +	DO6	P5.2 +	DO22
P1.2 -		P5.2 -	
P1.3 +	DO7	P5.3 +	DO23
P1.3 -		P5.3 -	
P2.0 +	DO8	P6.0 +	DO24
P2.0 -		P6.0 -	
P2.1 +	DO9	P6.1 +	DO25
P2.1 -		P6.1 -	
P2.2 +	DO10	P6.2 +	DO26
P2.2 -		P6.2 -	
P2.3 +	DO11	P6.3 +	DO27
P2.3 -		P6.3 -	
P3.0 +	DO12	P7.0 +	DO28
P3.0 -		P7.0 -	
P3.1 +	DO13	P7.1 +	DO29
P 3.1-		P 7.1-	
P3.2+	DO14	P7.2+	DO30
P3.2-		P7.2-	
P3.3+	DO15	P7.3+	DO31
P3.3-		P7.3-	

Front Panel Signal Descriptions

# XJ2 Connector Pinout (Rear)

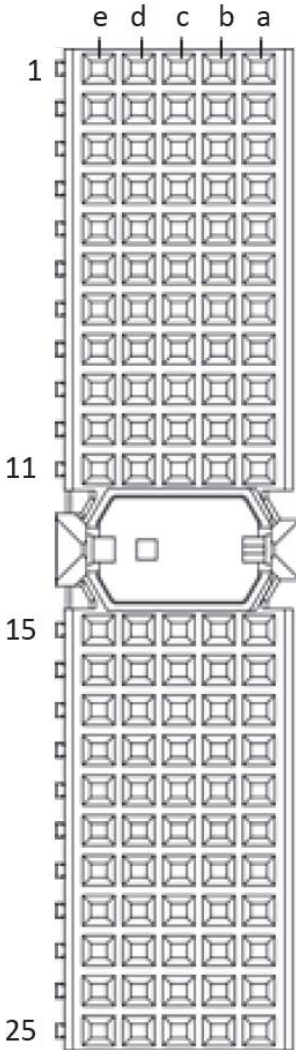

Row	e	d	c	b	a
1	DO 0	DO 1	NC	DO 2	DO 3
2	DO 4	DO 5	NC	DO 6	DO 7
3	DGND	DGND	DGND	DGND	DGND
4	DO 8	DO 9	NC	DO 10	DO 11
5	DO 12	DO 13	NC	DO 14	DO 15
6	DGND	DGND	DGND	DGND	DGND
7	DO 16	DO 17	NC	DO 18	DO 19
8	DO 20	DO 21	NC	DO 22	DO 23
9	DGND	DGND	DGND	DGND	DGND
10	DO 24	DO 25	NC	DO 26	DO 27
11	DO 28	DO 29	NC	DO 30	DO 31
15	NC	NC	NC	NC	NC
16	NC	NC	NC	NC	NC
17	DGND	DGND	DGND	DGND	DGND
18	NC	NC	NC	NC	NC
19	NC	NC	NC	NC	NC
20	DGND	DGND	DGND	DGND	DGND
21	NC	NC	NC	NC	NC
22	NC	NC	NC	NC	NC
23	DGND	DGND	DGND	DGND	DGND
24	NC	NC	NC	NC	NC
25	NC	NC	NC	NC	NC

XJ2 Connector Pin Assignments

Signal	Description
DO	Digital output signal connection
GND	Ground connection
NC	No connection

XJ2 Connector Signal Descriptions

# LED Behavior

---

LED Name	LED Behavior	Definition of Behavior
PWR	Off	No power present on the board
	Solid green	Power good state
RDY	Off	Module card is unpowered
	Solid green	Card is recognized by the chassis and ready to communicate
	Solid amber	Module card is booting
	Blinking amber	Chassis is communicating with the module card

# Error Handling

---

LED Name	LED Behavior	Actions
PWR	Off	<ul style="list-style-type: none"><li>- Check the power supply of the chassis.</li><li>- Check the external power supply if used.</li></ul>
RDY	Blinking Red	<ul style="list-style-type: none"><li>- Switch off and switch on the power supply (power cycle).</li><li>- Please contact the support.</li></ul>



# Hardware Specifications

Absolute Maximum Ratings			
Property	Condition	Value	Comment
Max. Input Voltage	Any Pin	60 Vdc	
Min. Input Voltage	Any Pin	-60 Vdc	
Channel to Channel		120 Vdc	
Channels to Chassis		60 Vdc	

Technical Data			
Property	Condition	Value	Comment
Max. Input Voltage		60 V	Overall temp. range
Min. High Level Input Voltage		2.3 V	
Input Current	$V_{IN} > 5 V$	4 mA $\pm$ 2 mA	
Max. Input Frequency	Square wave, 0 V to 10 V	40 kHz	
Propagation Delay	Any Channel, Rising Edge	Typ: 2.7 $\mu$ s Max: 3.6 $\mu$ s	Overall temp. range
	Any Channel, Falling Edge	Typ: 8.4 $\mu$ s Max: 12,5 $\mu$ s	Overall temp. range