

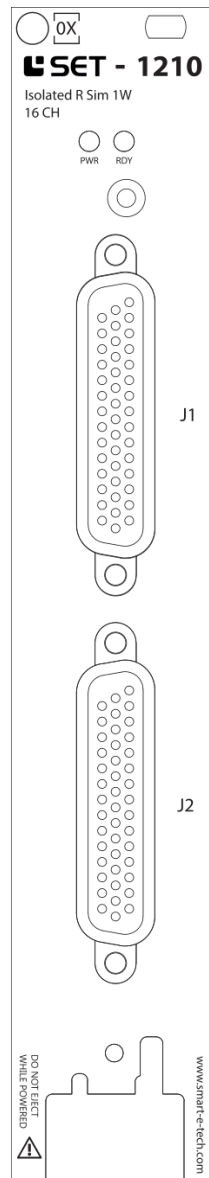

TECHNICAL DESCRIPTION

SET-1210 Resistor Simulation Card

16 Channel Resistor Simulation Card



This document 9040TDD0510 is a technical description of the SET-1210.

-  **Note** Before you begin, complete the software and hardware installation procedures applicable to your application.
-  **Note** The guidelines in this document are specific to the SET-1210. The other components in the system might not meet the same safety ratings. Refer to the documentation of each component in the system to determine the safety and EMC ratings for the entire system.

MORE INFORMATION ON OUR WEBSITE:

www.smart-e-tech.de/slsc

Safety Guidelines



Caution Do not operate the SET-1210 in a manner not specified in this document. Product misuse can result in a hazard. You can compromise the safety protection built into the product if the product is damaged in any way. If the product is damaged, return it for repair.

Electromagnetic Compatibility Guidelines

This product was tested and complies with the regulatory requirements and limits for electromagnetic compatibility (EMC). These requirements and limits provide reasonable protection against harmful interference when the product is operated in the intended operational electromagnetic environment.

This product is intended for use in industrial locations. However, harmful interference may occur in some installations, when the product is connected to a peripheral device or test object, or if the product is used in residential or commercial areas. To minimize interference with radio and television reception and prevent unacceptable performance degradation, install, and use this product in strict accordance with the instructions in the product documentation.

Furthermore, any changes or modifications to the product not expressly approved by SET GmbH could void your authority to operate it under your local regulatory rules.



Caution To ensure the specified EMC performance, operate this product only with shielded cables and accessories.



Caution To ensure the specified EMC performance, the length of any cable attached to connectors J1 and J2 must be no longer than 3 m (10 ft.)

Description

The SET-1210 provides a powerful solution for applications requiring simulation of resistive sensors.

The SET-1210 covers two ranges of values that meet the needs of most functional test systems. It is designed to applications such as the testing of engine controllers where resistive sensors provide information on parameters such as temperature.

Each channel of the SET-1210 card can simulate the common short circuit and open circuit conditions that can be experienced in a system due to faulty wiring or sensors.

Circuitry

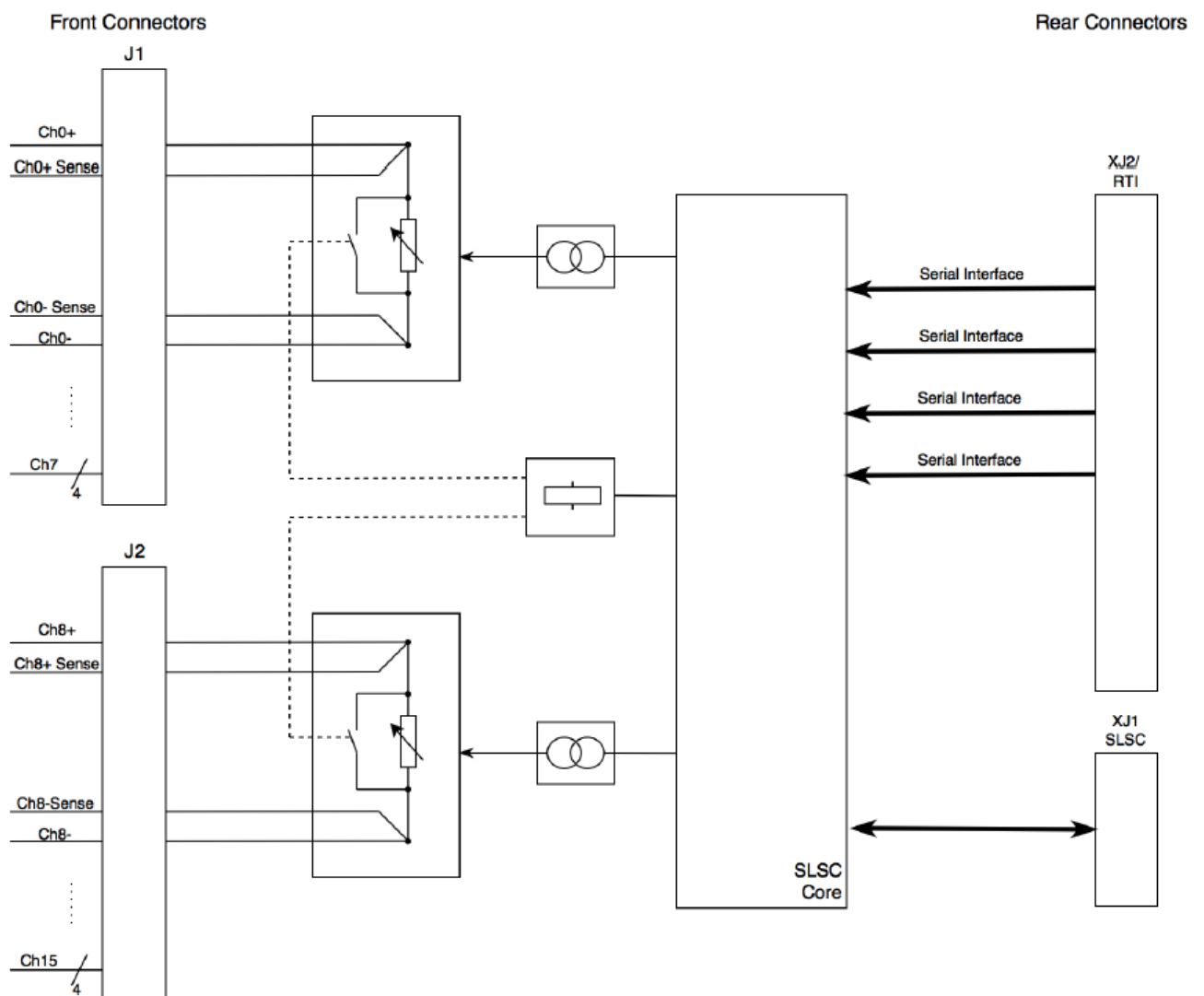

 **Note** Diagram only shows one channel.

J1, J2 Pinout (Front)

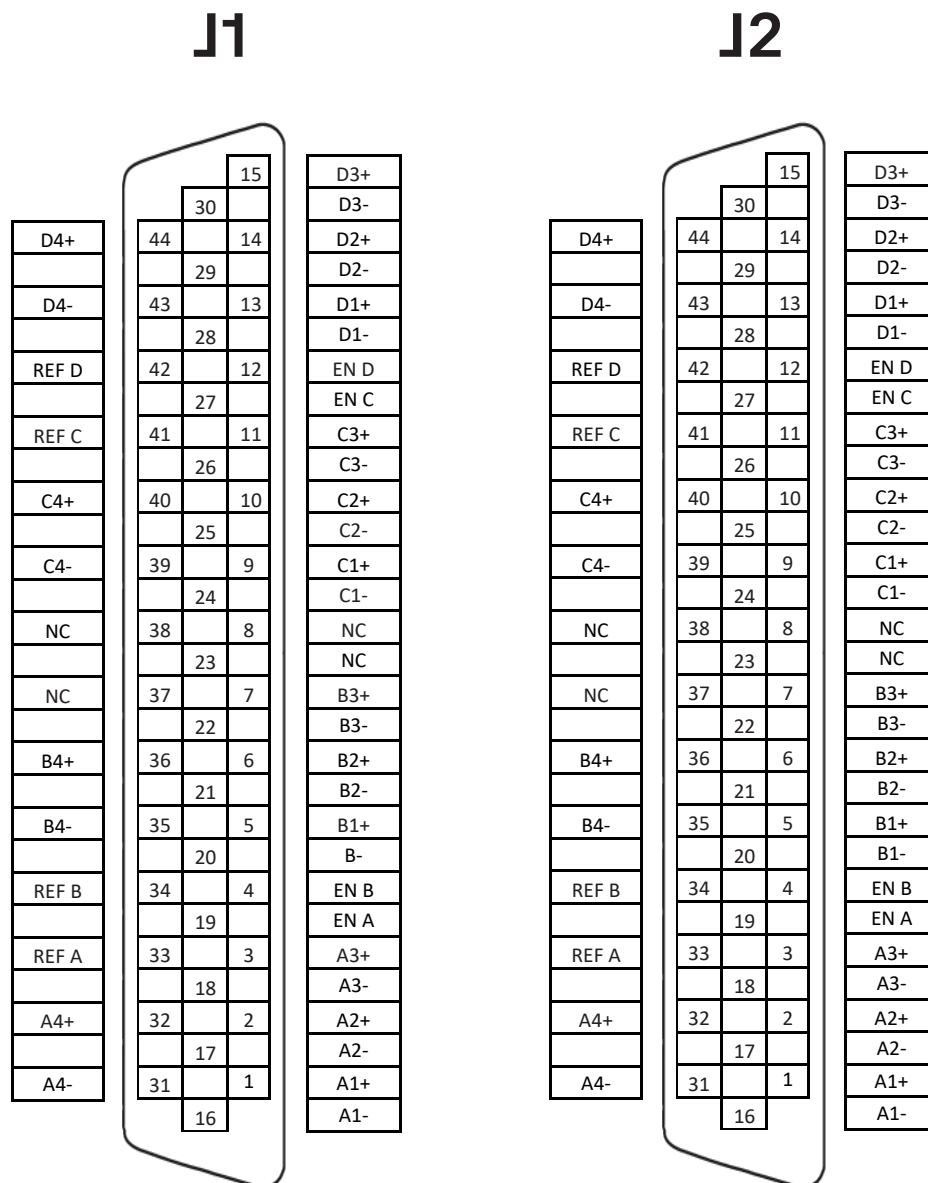

Signal	Description
A/B/C/D	Bank
NC	No connection
EN	Enable
REF	Reference

Table 1. J1, J2 Connector Pin Assignments

XJ2 Connector Pinout (Rear)

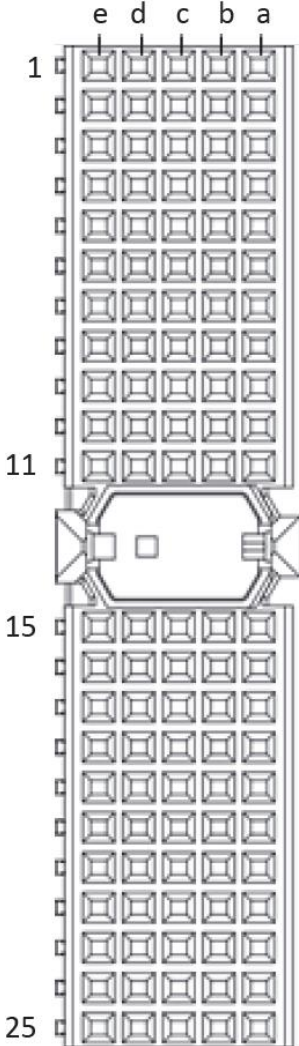

Row	f	e	d	c	b	a
1	DGND	DI 1_3 MOSI_1	DI 1_2 MOSI_0	NC	DI 1_1 CLK	DI 1_0: /CS
2	DGND	DI 1_7 MOSI_5	DI 1_6 MOSI_4	NC	DI 1_5 MOSI_3	DI 1_4: MOSI_2
3	DGND	DGND	DGND	DGND	DGND	DGND
4	DGND	DI 2_3 MOSI_1	DI 2_2 MOSI_0	NC	DI 2_1 CLK	DI 2_0 /CS
5	DGND	DI 2_7 MOSI_5	DI 2_6 MOSI_4	NC	DI 2_5 MOSI_3	DI 2_4 MOSI_2
6	DGND	DGND	DGND	DGND	DGND	DGND
7	DGND	DI 3_3 MOSI_1	DI 3_2 MOSI_0	NC	DI 3_1 CLK	DI 3_0 /CS
8	DGND	DI 3_7 MOSI_5	DI 3_6 MOSI_4	NC	DI 3_5 MOSI_3	DI 3_4 MOSI_2
9	DGND	DGND	DGND	DGND	DGND	DGND
10	DGND	DI 4_3 MOSI_1	DI 4_2 MOSI_0	NC	DI 4_1 CLK	DI 4_0 /CS
11	DGND	DI 4_7 MOSI_5	DI 4_6 MOSI_4	NC	DI 4_5 MOSI_3	DI 4_4 MOSI_2
12	NC	NC	NC	NC	NC	NC
13	NC	NC	NC	NC	NC	NC
14	NC	NC	NC	NC	NC	NC
15	DGND	NC	NC	NC	NC	NC
16	DGND	NC	NC	NC	NC	NC
17	DGND	DGND	DGND	DGND	DGND	DGND
18	DGND	NC	NC	NC	NC	NC
19	DGND	NC	NC	NC	NC	NC
20	DGND	DGND	DGND	DGND	DGND	DGND
21	DGND	NC	NC	NC	NC	NC
22	DGND	NC	NC	NC	NC	NC
23	DGND	DGND	DGND	DGND	DGND	DGND
24	DGND	NC	NC	NC	NC	NC
25	DGND	NC	NC	NC	NC	NC

Table 2. XJ2 Connector Pin Assignments

Signal	Description
DI x_y	
DGND	Detection Ground Connection
GND	Ground connection
NC	No connection

Table 3. XJ2 Connector Signal Descriptions

XJ3 Connector Pinout (Rear)

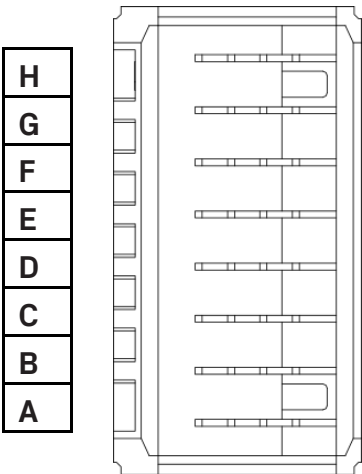

Pins	Signal	Slot1/Slot2
H	V1+	Instrument 0+
G	V1-	Instrument 0-
F	V2+	Instrument 1+
E	V2-	Instrument 1-
D	V3+	Fault A
C	V3-	Fault B
B	V4+	Fault C
A	V4-	Fault_D

Table 4. XJ2 Connector Pin Assignments

LED Behavior

LED Name	LED Behavior	Definition of Behavior
PWR	Off	No power present on the board
	Solid green	Power good state
RDY	Off	Module card is unpowered or reset active
	Solid green	Card is recognized by chassis and ready to communicate
	Amber	Chassis is communicating

Error Handling

LED Name	LED Behavior	Actions
PWR	Off	<ul style="list-style-type: none">- Check power supply of chassis- Check external power supply if used
PWR	Blinking Red	<ul style="list-style-type: none">- Check plugin module on board- Check fuse on board

Hardware Specifications

Absolute Maximum Ratings			
Property	Condition	Value	Comment
Max. Input Voltage	Any Pin	60 VDC	Transient 65 V
Min. Input Voltage	Any Pin	-60 VDC	Transient -65 V
Max. Switching Power	DC, Resistive load	60W	
Max. Current Rating		1.5A	

Technical Data			
Property	Condition	Value	Comment
Update Time		10ms	SLSC Commit CMD duration
Max Initial Contact Resistance	J1 -> XJ2, J2-> XJ2, J1 -> J2	500 mΩ	
Expected Electrical Lifetime	1A, 30V _{DC} resistive	10 ⁵ operations	
	1.5A, 30V _{DC} resistive	10 ⁴ operations	
Bandwidth	-3dB, 50 Ω Termination	≤ 20 MHz	

Physicals Characteristics			
Property	Condition	Value	Comment
Module Dimensions	Excluding ejector	144.32mm x 30.48mm x 302mm (H x W x D)	Standard SLSC card size
Weight		270g	
Front Panel Connectors		2 x female DB-44 high-density D-Sub with 4-40 UNC screw lock	For mating connectors and cables, see below
RTI Connectors		2mm hard metric per IEC 61076-4-101	Any RTI marked

Hardware Specifications

Environmental			
Property	Condition	Value	Comment
Relative Humidity	Non-condensing	5% to 95%	Non-condensing
Storage Humidity		5% to 95%	Non-condensing
Operating Temperature		0°C – 85°C	24 V supplied by SLSC chassis
Storage Temperature		-40°C-100°C	
Maximum altitude		2000 m	

