

TECHNICAL DESCRIPTION

SET-1415

16 Channel Input Card

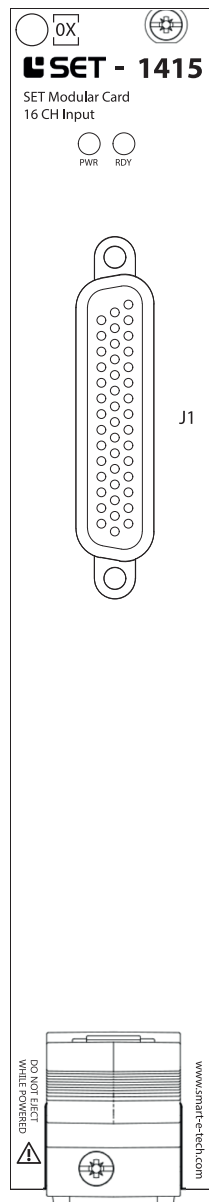

This document is a technical description of the SET-1415.



Note Before you begin, complete the software and hardware installation procedures applicable to your application.



Note The guidelines in this document are specific to the SET-1415. The other components in the system might not meet the same safety ratings. Refer to the documentation of each component in the system to determine the safety and EMC ratings for the entire system.

MORE INFORMATION ON OUR WEBSITE:

www.smart-e-tech.com/slsc

Safety Guidelines



Caution Do not operate the SET-1415 in a manner not specified in this document. Product misuse can result in a hazard. You can compromise the safety protection built into the product if the product is damaged in any way. If the product is damaged, return it for repair.

Electromagnetic Compatibility Guidelines

This product was tested and complies with the regulatory requirements and limits for electromagnetic compatibility (EMC). These requirements and limits provide reasonable protection against harmful interference when the product is operated in the intended operational electromagnetic environment.

This product is intended for use in industrial locations. However, harmful interference may occur in some installations, when the product is connected to a peripheral device or test object, or if the product is used in residential or commercial areas. To minimize interference with radio and television reception and prevent unacceptable performance degradation, install and use this product in strict accordance with the instructions in the product documentation.

Furthermore, any changes or modifications to the product not expressly approved by SET GmbH could void your authority to operate it under your local regulatory rules.



Caution To ensure the specified EMC performance, operate this product only with shielded cables and accessories.





Caution To ensure the specified EMC performance, the length of any cable attached to connectors J1 must be no longer than 3 m (10 ft.)

Description

The carrier card of the SET-1415 Modular Input Card offer slots for eight function / measuring modules of the SET “SMARTbrick” or “AEROSpice” series. The SET-1415 serving different applications like simple signal routing and conditioning up to complex signal simulation via the “SMARTbrick” or “AEROSpice” modules. The slots provide power to the modules and connect the individual modules to the carrier modules Inter-Modul-Bus. The modular card 1415 communicates with the higher-level test system.

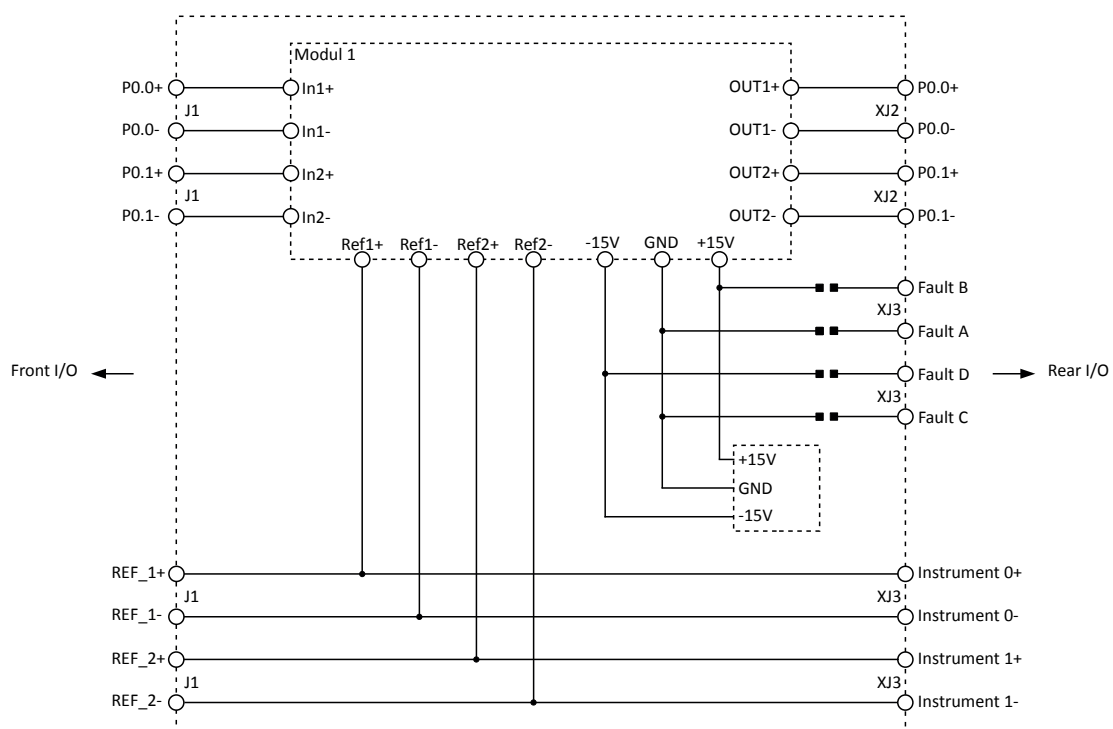
Circuitry



 **Note** Diagram only shows one out of 8 modules per front connector J1.

Circuitry

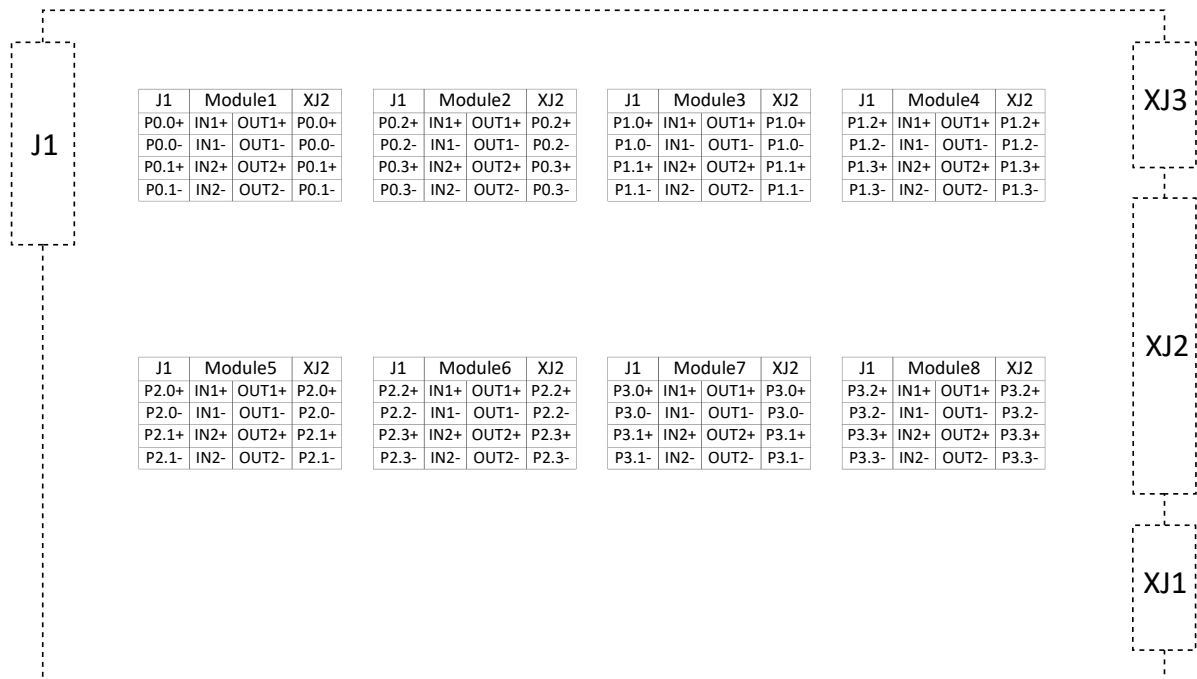

 **Note** Diagram shows the pin assignment of the modules to the connectors J1 and XJ2.

All voltages are relative to GND unless otherwise noted.

 **Note** You can configure the power-on configuration in the software. The factory default power-on configuration sets the front I/O channels to sinking input and rear I/O channels to input.

J1 Pinout (Front)

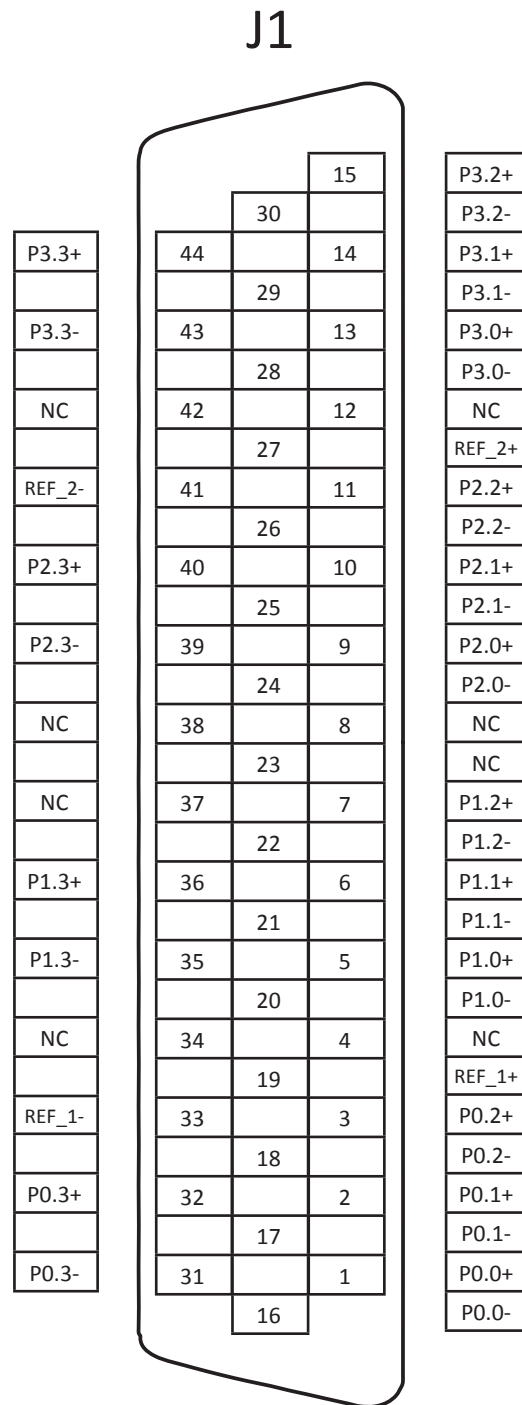

Signal	Description
Px.y	Line y in Port x
NC	No connection
REF	Reference

J1 Connector Pin Assignments

XJ2 Connector Pinout (Rear)

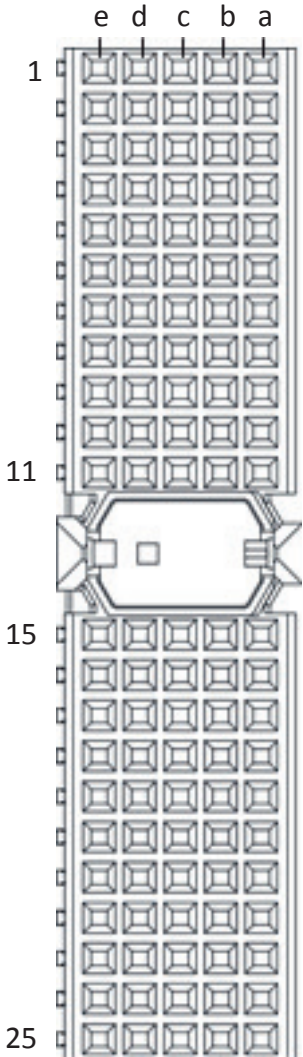

Row	a	b	c	d	e
1	P0.0+	P0.0-	NC	P0.1+	P0.1-
2	P0.2+	P0.2-	NC	P0.3+	P0.3-
3	GND	GND	GND	GND	GND
4	P1.0+	P1.0-	NC	P1.1+	P1.1-
5	P1.2+	P1.2-	NC	P1.3+	P1.3-
6	GND	GND	GND	GND	GND
7	P2.0+	P2.0-	NC	P2.1+	P2.1-
8	P2.2+	P2.2-	NC	P2.3+	P2.3-
9	GND	GND	GND	GND	GND
10	P3.0+	P3.0-	NC	P3.1+	P3.1-
11	P3.2+	P3.2-	NC	P3.3+	P3.3-
12	NC	NC	NC	NC	NC
13	NC	NC	NC	NC	NC
14	NC	NC	NC	NC	NC
15	P4.0+	P4.0-	NC	P4.1+	P4.1-
16	P4.2+	P4.2-	NC	P4.3+	P4.3-
17	GND	GND	GND	GND	GND
18	NC	NC	NC	NC	NC
19	NC	NC	NC	NC	NC
20	GND	GND	GND	GND	GND
21	NC	NC	NC	NC	NC
22	NC	NC	NC	NC	NC
23	GND	GND	GND	GND	GND
24	NC	NC	NC	NC	NC
25	NC	NC	NC	NC	NC

XJ2 Connector Pin Assignments

Signal	Description
GND	Ground connection
NC	No connection

XJ2 Connector Signal Descriptions

XJ3 Connector Pinout (Rear)

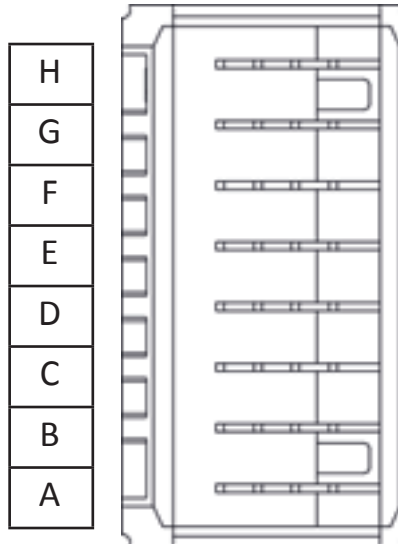

Pins	Signal	Slot1/Slot2
H	V1+	Instrument_0+
G	V1-	Instrument_0-
F	V2+	Instrument_1+
E	V2-	Instrument_1-
D	V3+	Fault_A
C	V3-	Fault_B
B	V4+	Fault_C
A	V4-	Fault_D

XJ3 Connector Pin Assignments

LED Behavior

LED Name	LED Behavior	Defintion of Behavior
PWR	Off	No power on the board
	Solid green	Power good state
RDY	Off	Module card is unpowered or reset active
	Solid green	Card is recognized by the chassis and ready to communicate
	Amber	Chassis is communicating

Error Handling

LED Name	LED Behavior	Actions
PWR	Off	<ul style="list-style-type: none">- Check the power supply of the chassis- Check the external power supply if used
PWR	Blinking Red	<ul style="list-style-type: none">- Check fuse on board- Switch off and switch on the power supply (power cycle)- Please contact the support

Hardware Specifications

Absolut Maximum Ratings			
Property	Condition	Value	Comment
Max. Input Voltage	Any Pin	60Vdc	
Min. Input Voltage	Any Pin	-60Vdc	

 **Note** Max. ratings depending on the SmartBrick or AeroSpice plugin modules.

Technical Data			
Property	Condition	Value	Comment
Max. Current +15V	Modules 1-4	200mA	
	Modules 5-8	200mA	
Max. Current -15V	Modules 1-4	200mA	
	Modules 5-8	200mA	
Max. Current Ref_x to Instrument X		1500mA	by temp. rise from 30°C

Hardware Specifications

Physical Characteristics			
Property	Condition	Value	Comment
Module Dimensions	Excluding ejector	144.32mm x 30.48mm x 302mm (H x W x D)	Standard SLSC card size
Front Panel Connector		1x female DB -44 high-density D-Sub with 4-40 UNC screw lock	
RTI Connector		2mm hard metric per IEC 61076-101	Any RTI marked

Environmental			
Property	Condition	Value	Comment
Operating Humidity	Relative, non-condensing	10%-90%	
Storage Humidity	Relative, non-condensing	5%-95%	
Operating Temperature	Forced-air cooling from chassis	0°C-40°C	
Storage Temperature		-40°C-85°C	
Maximum Altitude		2000m	